

# Kenmore®

## Portable Air Conditioner

Dehumidifier & Heater with Remote Control

## Aire Acondicionado Portátil

Deshumidificador y Calentador con Control Remoto

Model/Modelo: 408.72012

P/N 620209-0Y-6-A  
Sears Brands Management Corporation  
Hoffman Estates, IL 60179 U.S.A.  
[www.kenmore.com](http://www.kenmore.com)  
[www.sears.com](http://www.sears.com)



## Get it fixed, at your home or ours!

### Your Home

For troubleshooting, product manuals and expert advice:



[www.managemylife.com](http://www.managemylife.com)

For repair – **in your home** – of **all** major brand appliances, lawn and garden equipment, or heating and cooling systems, **no matter who made it, no matter who sold it!**

For the replacement parts, accessories and owner's manuals that you need to do-it-yourself.

For Sears professional installation of home appliances and items like garage door openers and water heaters.

**1-800-4-MY-HOME®**

(1-800-469-4663)

[www.sears.com](http://www.sears.com)

Call anytime, day or night

(U.S.A. and Canada)

[www.sears.ca](http://www.sears.ca)

### Our Home

For repair of carry-in items like vacuums, lawn equipment, and electronics, call anytime for the location of the nearest

**Sears Parts & Repair Service Center**

**1-800-488-1222** (U.S.A.)

[www.sears.com](http://www.sears.com)

**1-800-469-4663** (Canada)

[www.sears.ca](http://www.sears.ca)

To purchase a protection agreement on a product serviced by Sears:

**1-800-827-6655** (U.S.A.)

**1-800-361-6665** (Canada)

Para pedir servicio de reparación a domicilio, y para ordenar piezas:

**1-888-SU-HOGAR®**

(1-888-784-6427)

[www.sears.com](http://www.sears.com)

Au Canada pour service en français:

**1-800-LE-FOYER<sup>MC</sup>**

(1-800-533-6937)

[www.sears.ca](http://www.sears.ca)

## TABLE OF CONTENTS

Before Using Your New Air Conditioner .....	2	Safety Plug .....	11
Important Safeguards .....	3-5	Control Panel .....	11-13
Kemore Air Conditioner Warranty .....	6	Remote Control .....	13-14
Master Protection Agreement .....	7	Operating Instructions .....	15-18
Unpacking Instructions .....	8	Cleaning & Maintenance .....	18-19
Air Conditioner Parts .....	8	Storage .....	20
Accessories .....	9	Technical Specifications .....	20
Installation .....	9-10	Troubleshooting .....	21-22
		Notes .....	23

## BEFORE USING YOUR NEW AIR CONDITIONER

READ THIS USE & CARE GUIDE CAREFULLY AND THOROUGHLY BEFORE INSTALLING AND OPERATING YOUR AIR CONDITIONER.

RETAIN THIS USE & CARE GUIDE FOR FUTURE REFERENCE.

## IMPORTANT SAFEGUARDS

To prevent injury to the user or other people and property damage, the following instructions must be followed.

- Use this appliance only as described in this Use & Care Guide. As with any electrical appliance, the instructions aim to cover as many eventualities as possible. Caution and common sense should be used when operating and installing this air conditioner.
- This appliance has been manufactured to cool, heat and dehumidify domestic environments and should not be used for other purposes.
- The appliance should not be installed where the atmosphere may contain combustible gases, oil or sulphur, or near heat sources.
- Always install the portable air conditioner properly. Incorrect assembly or installation may cause failure to operate including injury, fire and electric shock hazards.
- Do not place the power cord near a heater. It may cause fire or electric shock.
- Do not use the power cord near flammable gas or combustibles such as gasoline, benzene, thinner, etc. It may cause explosion or fire.
- Do not operate or stop the unit by inserting or pulling out the power plug. It may cause fire or electric shock.
- Do not damage or use an unspecified power cord. It may cause fire or electric shock.
- Do not modify the length of the power cord. It will cause fire or electric shock due to heat generation.
- Use the air conditioner on a single outlet circuit. Do not share the outlet with other appliances. It may cause circuit failure.
- Changing the outlet without making the appropriate wiring changes will create an unsafe condition that could result in fire or electric shock. Refer all such work to a licensed and qualified electrician.
- **WARNING:** This appliance must be properly grounded. The power cord of this appliance is equipped with a three-prong LCDI (Leakage Current Detection and Interruption) plug. To minimize the risk of electric shock, use the plug with a standard three-slot grounding wall power outlet. If power outlet does not include a grounding slot, have a qualified electrician replace the outlet before you use your room air conditioner. Do not cut or remove the grounding prong from the power plug. If you have doubt whether the air conditioner is properly grounded, have the wall receptacle and circuit checked by a qualified electrician.
- Do not disassemble or modify this appliance. Doing so may cause failure and electric shock.

## IMPORTANT SAFEGUARDS

- TEMPORARY USE OF AN EXTENSION CORD. We strongly discourage the use of an extension cord due to potential safety hazards. For temporary situations, use only CSA and UL certified 3-prong grounded extension cords designed and approved specifically for air conditioners.
- To prevent injury from handling sharp objects, do not touch the metal parts of the unit when removing the filter.
- Do not block the air inlet or air outlet. It may cause failure of the appliance.
- Always store and transport the air conditioner upright to maintain the compressor in a proper condition. Prior to installation, allow air conditioner to stand upright for 12 hours.
- Only operate the unit on an even horizontal surface to ensure no water leaks.
- This appliance is not intended for use by persons (including children) with reduced physical, sensory or mental capabilities, or lack of experience and knowledge, unless they have been given supervision or instruction concerning use of the appliance by a person responsible for their safety. Children should be supervised to ensure that they do not play with the appliance.
- Do not insert the power plug into a wall outlet if either is loose or damaged. It may cause fire and electric shock.
- Unplug the unit if strange sounds, odors or smoke come from it.
- Hold the plug by the head when unplugging the unit. Do not pull on the cord.
- Unplug the air conditioner if it will not be used for a long period to prevent accidental startup and the possibility of injury.
- Do not place heavy objects on the power cord, and take care so that the cord will not be damaged.
- Clean the air filters regularly. A contaminated air filter reduces capacity.
- Use a soft cloth to clean. Do not use wax, thinners or a strong detergent. The appearance of the air conditioner may deteriorate, change color or develop surface flaws.
- Do not use water to clean inside the air conditioner. Exposure to water can destroy the insulation, leading to possible electric shock.
- If water enters the product, turn off the power switch of the main body of the appliance.
- Being exposed to direct airflow for an extended period of time could be hazardous to your health.

## IMPORTANT SAFEGUARDS

- Do not use this air conditioner for refrigeration purposes (e.g. preserving precision devices, food, pets, plants and art objects.)
- Due to the possibility of oxygen deficiency within the room, ventilate the room when used together with stoves or other heating devices.
- The air conditioner is a consumer comfort appliance, not a precision climate control system.
- Always insert the filter securely. Never operate without a filter.
- Do not drink water drained from air conditioner. It contains contaminants that may make you sick.
- Do not use this unit in conditions where the temperature may fall below 50°F (10°C). Failure to do so can cause severe damage to the unit.

## KENMORE PORTABLE AIR CONDITIONER WARRANTY

### Kenmore Limited Warranty

When this product is installed, operated and maintained according to all supplied instructions, the following warranty coverage applies. To arrange for warranty service, call 1-800-4-MY-HOME®

- For five years from the date of purchase, this product will be replaced free of charge if the sealed refrigerant system fails due to defects in material or workmanship.
- For one year from the date of purchase, this product will be repaired free of charge for defects in material or workmanship to all components other than the sealed refrigerant system.

All warranty coverage applies for only 90 days from the date of purchase if this product is ever used for other than private family purposes.

**This warranty covers only defects in material and workmanship.**

**Sears will NOT pay for:**

1. Expendable items that can wear out from normal use, including but not limited to filters, belts, light bulbs, and bags.
2. A service technician to instruct the user in correct product installation, operation or maintenance.
3. A service technician to clean or maintain this product.
4. Damage to or failure of this product if it is not installed, operated or maintained according to the all instructions supplied with the product.
5. Damage to or failure of this product resulting from accident, abuse, misuse or use for other than its intended purpose.
6. Damage to or failure of this product caused by the use of detergents, cleaners, chemicals or utensils other than those recommended in all instructions supplied with the product.
7. Damage to or failure of parts or systems resulting from unauthorized modifications made to this product.

### Disclaimer of implied warranties; limitation of remedies

Customer's sole and exclusive remedy under this limited warranty shall be product repair as provided herein. Implied warranties, including warranties of merchantability or fitness for a particular purpose, are limited to one year or the shortest period allowed by law. Sears shall not be liable for incidental or consequential damages. Some states and provinces do not allow the exclusion or limitation of incidental or consequential damages, or limitation on the duration of implied warranties of merchantability or fitness, so these exclusions or limitations may not apply to you.

This warranty applies only while this appliance is used in the United States or Canada.

This warranty gives you specific legal rights, and you may also have other rights which vary from state to state.

Sears, Roebuck and Co., Hoffman Estates, IL 60179  
Sears Canada Inc., Toronto, Ontario, Canada M5B 2C3

## MASTER PROTECTION AGREEMENT

### Master Protection Agreements

Congratulations on making a smart purchase. Your new Kenmore® product is designed and manufactured for years of dependable operation. But like all products, it may require preventive maintenance or repair from time to time. That's when having a Master Protection Agreement can save you money and aggravation.

The Master Protection Agreement also helps extend the life of your new product. Here's what the Agreement\* includes:

- ☑ **Parts and labor** not just for repairing defects, but to help keep products operating properly under normal use. Our coverage goes well beyond the product warranty. No deductibles, no functional failure excluded from coverage—real protection.
- ☑ **Expert service** by a force of more than 10,000 authorized Sears service technicians, which means someone you can trust will be working on your product.
- ☑ **Unlimited service calls and nationwide service**, as often as you want us, whenever you want us.
- ☑ **"No-lemon" guarantee**—replacement of your covered product if four or more product failures occur within twelve months.
- ☑ **Product replacement** if your covered product can't be fixed.
- ☑ **Annual Preventive Maintenance Check** at your request—no extra charge.
- ☑ **Fast help by phone**—we call it **Rapid Resolution**—phone support from a Sears representative on all products. Think of us as a "talking owner's manual".
- ☑ **Power surge protection** against electrical damage due to power fluctuations.
- ☑ **\$250 Food Loss Protection** annually for any food spoilage that is the result of mechanical failure of any covered refrigerator or freezer.
- ☑ **Rental reimbursement** if repair of your covered product takes longer than promised.
- ☑ **10% discount** off the regular price of any non-covered repair service and related installed parts.

Once you purchase the Agreement, a simple phone call is all that it takes for you to schedule service. You may call anytime, day or night, or schedule a service appointment online.

The Master Protection Agreement is a risk free purchase. If you cancel for any reason during the product warranty, we will provide a full refund. Or, a prorated refund anytime after the product warranty period expires. Purchase your Master Protection Agreement today!

**Some limitations and exclusions apply. For prices and additional information in the U.S.A. call 1-800-827-6655.**

\*Coverage in Canada varies on some items. For full details call Sears Canada at 1-800-361-6665.

### Sears Installation Service

For Sears professional installation of home appliances, garage door openers, water heaters, and other home items, in the U.S.A. or Canada call 1-800-4-MY-HOME®.

## UNPACKING INSTRUCTIONS

1. Place the unit in the correct upright position before unpacking.
2. Cut the two packing straps.
3. Slide the carton in an upward motion and it will release from the base. (We recommend that you retain the packaging for offseason storage)
4. Grip the unit by the recessed carry handles on each side, and carefully lift unit until it slides free from foam base.

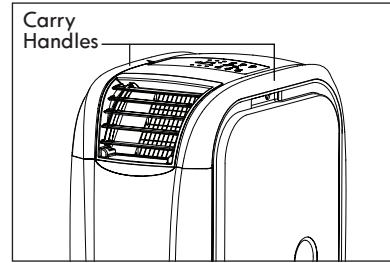

## AIR CONDITIONER PARTS

Remove the air conditioner from the packing carton. It is recommended to keep the carton and packing material for storage or transportation of the unit.

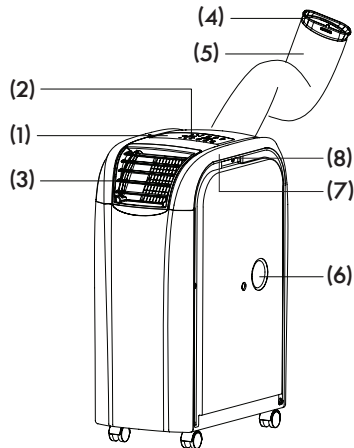

### Front of Unit (Fig. 1)

1. Control Panel
2. Remote receiver
3. Adjustable air vent
4. Hose joint
5. Exhaust hose
6. Upper drain outlet
7. Carry handles
8. Remote receiver jack

Fig. 1

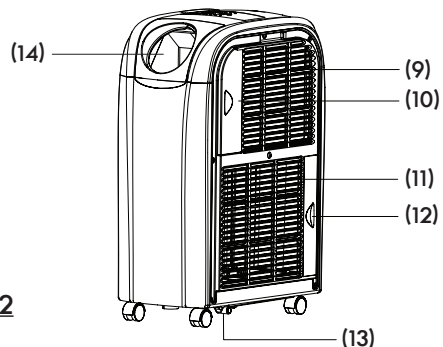

### Rear of Unit (Fig. 2)

9. Cool air inlet
10. Cool air filter
11. Warm air inlet
12. Warm air filter
13. Lower drain outlet
14. Exhaust hose holder

Fig. 2

## ACCESSORIES

On initial unit setup, check that all the accessories listed below are included:

Exhaust hose

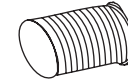

Remote sensor kit  
(used only in out-of-room cooling mode)



2 AAA batteries



Drain hose for continuous drainage  
(16 mm inner diameter)

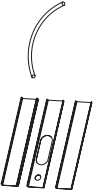

Window kit  
(3 pcs)



Remote control

## INSTALLATION

Prior to installing the unit, check for the following:

1. To avoid damage, place the unit in an upright position for at least 12 hours before initial operation. This ensures all lubricating oil has settled to the bottom of the compressor, avoiding damage to other internal parts.
2. Lift the exhaust hose holder (1) from the unit to expose the exhaust hose and accessories. Remove the accessories from the hose and set aside. Turn the hose in the direction of arrow (2) to completely remove the hose from the unit. Return the exhaust hose holder to the unit.
3. The hose has a window connection end and a unit connection end. Expand the unit connection end and insert it into the exhaust hose holder. Turn the hose several turns in the direction of arrow (3) until it is securely attached in the holder.

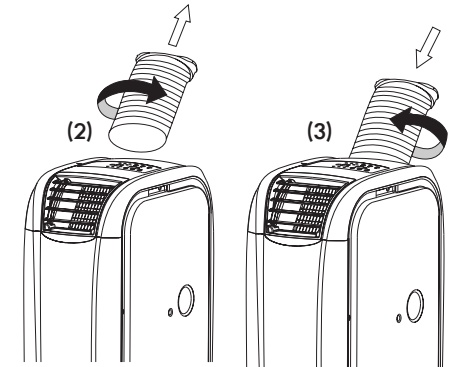
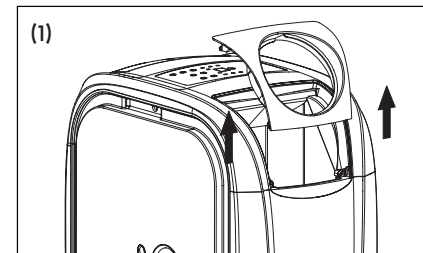

4. Plug the unit into a 120V~60Hz grounded electrical outlet. **DO NOT USE A REGULAR EXTENSION CORD.** If it is necessary to use an extension cord with this unit, use an approved air conditioner extension cord only.

## INSTALLATION

### LOCATION OF THE PORTABLE AIR CONDITIONER

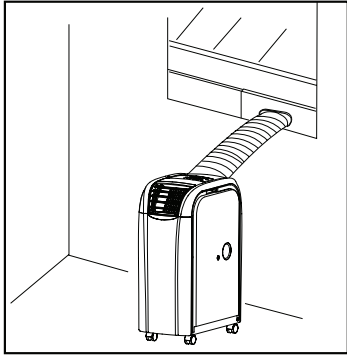

1. Select a location near a window and electrical outlet.
2. Position the unit in a flat, spacious location with a minimum of one foot of clearance (30 cm) between the air outlets and any wall or pieces of furniture.
3. If placing the unit outside of the room to be cooled, position it on a flat solid surface, preferably in a space with overhead shielding from rain and the direct rays of the sun. Do not operate the unit in extremely moist areas such as a sauna.

### WINDOW KIT INSTALLATION

The Window Kit (included) contains three sliding pieces, and can be adjusted to fit most standard vertical and horizontal windows (see Figs. 1 & 1a). For very wide windows, use all three pieces. For very narrow windows, you may have to cut down the end of the piece with the hose attachment hole. Do not cut into the hole.

### EXHAUST HOSE CONNECTION

The exhaust hose must be attached to the appropriate side of the unit given the desired application, either cooling or heating (see Operating Instructions). When changing applications, switch the adjustable air vent and exhaust hose holder (hose can remain attached) to the opposite sides of the unit.

Fig. 1



Window kit  
Min: 19 in.  
(48 cm)  
Max: 50 in.  
(127 cm)

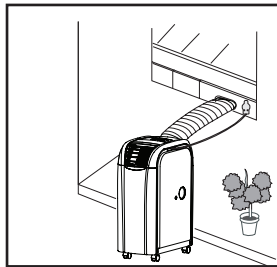

Vertical Window

Fig. 1a

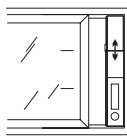

Window kit  
Min: 19 in.  
(48 cm)  
Max: 50 in.  
(127 cm)

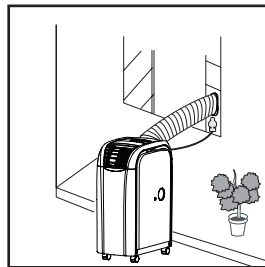

Horizontal Window

## SAFETY PLUG

This product is equipped with an LCDI (Leakage Current Detection and Interruption) safety plug. If power shuts off, unplug from the electrical outlet and make sure the cord is undamaged. If the cord is damaged, return the unit to a Sears Service Center for repair before using it again.

### TO TEST THE SAFETY PLUG

1. Connect the power plug to an electrical outlet.
2. The power plug has two buttons located on the top. One button is marked "TEST" and the other is marked "RESET". Press the "TEST" button; you will hear a click as the "RESET" button pops out.
3. Press the "RESET" button; you will hear a click as the button engages.
4. The power supply cord is now energized and supplying electricity to the air conditioner (it is indicated by a light on the plug head).
  - Under no circumstances should this device be used to turn the unit on or off.
  - The "RESET" button must always be pushed in (engaged) for correct operation.
  - The power supply cord must be replaced if it fails to reset when the "TEST" button is pushed in.

## CONTROL PANEL

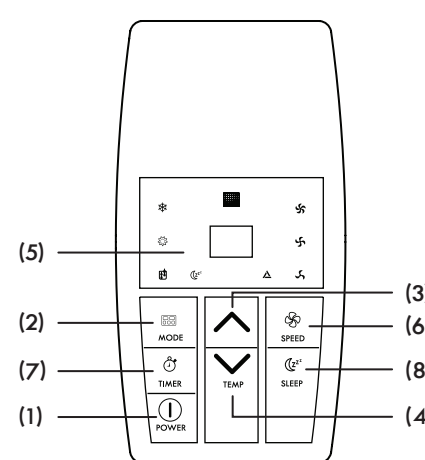

### 1. POWER

Press this button to switch the unit on or off.

### 2. MODE

Press this button to select between Cooling (), Heating () or Dehumidifying () mode.

**NOTE:** To change display between °F and °C, press the MODE button for 10 seconds with the power off and unit plugged in (Standby Mode). You will hear a beep when the change occurs.

### 3. TEMP+

- Pressing this button in cooling mode increases the desired room temperature setting by 1°F (1°C) up to a maximum setting of 86°F (30°C).
- Pressing this button in heating mode increases the desired room temperature setting by 1°F (1°C) up to a maximum setting of 77°F (25°C).





## CONTROL PANEL

### 4. TEMP-

- Pressing this button in cooling mode decreases the desired room temperature setting by 1°F (1°C) down to a minimum setting of 63°F (17°C).
- Pressing this button in heating mode decreases the desired room temperature setting by 1°F (1°C) down to a minimum setting of 59°F (15°C).





### 5. LED DISPLAY

The display shows the current temperature setting.

By pressing the () or () buttons, the temperature setting can be changed.

When pressing the timer button () , the number of hours is shown until delayed start-up or delayed shutdown. After each setting, the display returns to showing the current temperature setting. In the dehumidifying mode, “dh” is shown on the display. Error codes are also shown in the display. See Troubleshooting section for Error code definitions.

### 6. SPEED

Pressing this button sets the ventilator fan speed to “ (low)”, “ (medium)”, “ (high)” or “ (automatic)”.

When () is selected:

- If the set temperature is more than 16.2° F ( 9° C) different than room temperature, the fan will run at full speed.
- If the set temperature is less than 9° F (4° C) different than room temperature, the fan will run at medium speed.
- When the set temperature is reached, the fan will run at low speed. When the temperature becomes more than 9° F (4°C) different than room temperature, the fan will change to medium speed.

### 7. TIMER

Programmable timer button for delayed start-up or delayed shutdown.

#### How to program a delayed start-up

This function is used to set the number of hours delay before the appliance comes on. Proceed as follows:

- With the power ON, select the desired Mode of operation (Cool, Heat or Dehumidify)
- Turn the power OFF.
- Press the TIMER button (“00” will blink in the display). While the display is blinking, use the up and down buttons to set the number of hours delay before the unit begins operation.
- Wait a few seconds for the display to show the set temperature. Use the up and down buttons to adjust the set temperature if desired.
- After the set number of hours has expired, the unit starts automatically.

**NOTE:** If you press the POWER button before the set delay time has expired, the delay setting will cancel and the unit will immediately turn ON.

## CONTROL PANEL

### How to program a delayed shutdown

This function is used to set the number of hours delay before the appliance shuts off. Proceed as follows:

- With the power ON, select the desired Mode of operation (Cool, Heat or Dehumidify).
- Press the TIMER button (“00” will blink in the display). While the display is blinking, use the up and down buttons to set the desired number of hours until shutdown.
- Wait a few seconds for the display to show the set temperature. Use the up and down buttons to adjust the set temperature if desired.
- After the set number of hours has expired, the unit shuts down automatically.

**NOTE:** If you press the POWER button before the set shutdown time has expired, the unit will shut down immediately.

### 8. SLEEP

The Sleep mode is ideal for nighttime operation, as it automatically reduces the fan speed and minimizes the compressor running, for the quietest operation.

While the unit is ON, press the SLEEP mode button. The unit will switch to low fan speed.

In COOLING mode, the temperature setting automatically increases by 2° F (1° C) each hour for the first two hours of operation. As a result, the Sleep function provides most cooling when you first go to bed. The two setting increases while you are sleeping compensate for the typical decrease in ambient temperature as the night progresses. If the ambient temperature becomes 2° F (1° C) cooler than the temperature setting, the compressor will turn off. The compressor turns back on when the ambient temperature becomes 2° F (1° C) warmer than the ambient temperature.

In HEATING mode, the temperature setting is automatically DECREASED like above, and the compressor turns off if the ambient temperature becomes 2° F (1° C) BELOW the setting.

If desired, the fan speed can be manually changed while in SLEEP mode.

SLEEP mode cannot be activated while the unit is in DEHUMIDIFY mode.

## REMOTE CONTROL

INSERTING BATTERIES - This remote control uses two AAA batteries.











- Remove the back cover of the remote control
- Insert two AAA 1.5V batteries, making sure they are in the correct position (see instructions inside battery compartment).
- Replace the cover.

**DO NOT** mix old and new batteries. **DO NOT** mix together Alkaline, Standard (Carbon-Zinc), or Rechargeable (Nickel-Cadmium) batteries.

Dispose of batteries properly. **DO NOT** leave batteries in the remote if it will not be used for longer than 2 months.

## REMOTE CONTROL

### USING THE REMOTE

LCD Display	Function
	Cooling
	Heating
	Dehumidifying
	Sleeping
	Timer ON/OFF
	Temperature
	Automatic Air Flow Speed
	High Speed
	Medium Speed
	Low Speed

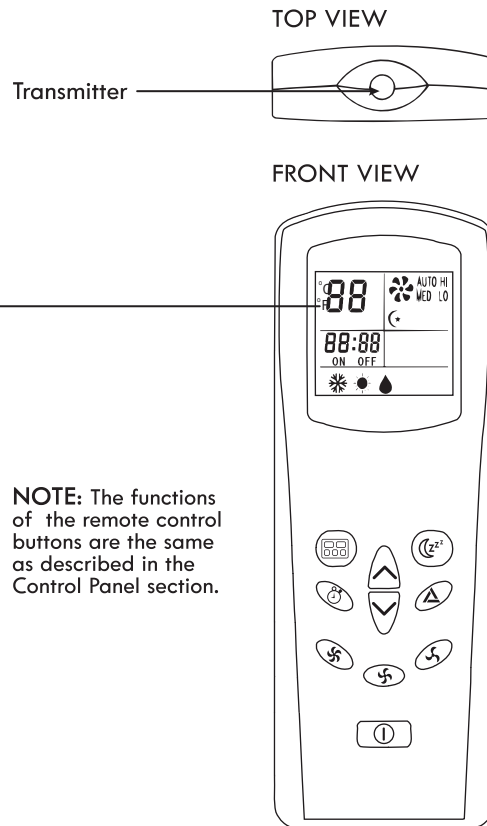

- The remote control must be within 16 feet (5 meters) of the receiver on the main unit. Reception is confirmed by a beep from the main unit.
- The remote control will not operate if curtains, doors or other material block the signal from the remote control to the receiver.
- Prevent any liquid from falling into the remote control. For proper remote control functioning, do not expose the window kit receiver to direct sunlight or heat.
- If other appliances react to the remote control, move them out of the way.
- When using the out-of-room air conditioning mode, point the remote control to the receiver in the window kit. Reception is confirmed by an LED flash in the receiver.
- Do not store the remote control where temperatures will be above 140°F (60°C) or below 23°F (-5°C).
- **IMPORTANT:** If you change the temperature scale (F° or C°) on the main unit control panel, you must also change the scale to be the same on the remote control. If not, the main unit scale will revert to that of the remote when you use the remote control. Hold the Mode button on the remote control for 10 seconds to change the temperature scale.

## OPERATING INSTRUCTIONS

**NOTE:** After switching the unit on, the ventilator fan operates, but the compressor only starts after the mode indicator has flashed for 3 minutes. Cool air will start to blow once the compressor starts, but it may take up to another 5 minutes to feel the cooling effect in the room. This is done as a protection mechanism to prolong compressor life. Further information is available in the "Troubleshooting" section.

### AIR CONDITIONING MODE – IN-ROOM OPERATION

The unit stands in the room to be cooled.

We recommend starting your unit early in the morning on warm days for maximum effect. This unit has a self-evaporation system to eliminate water that condenses in the unit during cooling; there is no water tank to empty. The drainage hose **MUST NOT** be connected for IN-ROOM air conditioning mode. Please make sure that the water outlet is closed with the rubber cap installed during operation.

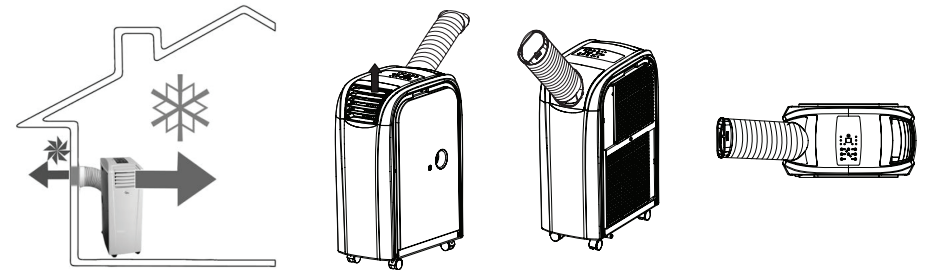

- Connect the exhaust hose and the adjustable air vent to the unit as displayed in the illustration. The hose must be connected to the side with the warm air icon (☀). The warm air emitted from unit must exit the room through the exhaust hose.
- Use the MODE button to set the unit function to COOLING. Adjust the set temperature using the TEMP up or down buttons. The cooling temperature can be set from 65°F to 90°F (17°C to 32°C).



## OPERATING INSTRUCTIONS

### AIR CONDITIONING MODE – OUT-OF-ROOM OPERATION

The unit is outside the room to be cooled, such as an adjacent room or hallway, or outdoors beneath a porch or window awning or the overhanging eaves of a roof.

Connect the air hose and the adjustable air vent to the unit as displayed in the illustration; hose must be connected to the side with the COOL icon (❄️). If the unit is placed out-of-room during high humidity periods, connect the supplied drainage hose to the lower drain outlet for effective cooling and additional moisture removal. Direct the end of the hose away from the unit.

If the unit is working in conditions of high humidity it may display an E4 error code. See Troubleshooting section.

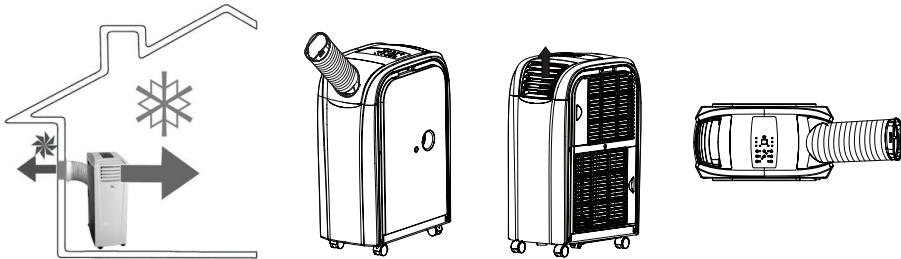

- For out-of-room operation, position the unit on a flat solid surface in an area protected from rain and sun exposure such as a sunroom, veranda or hallway. Do not operate the unit in extremely moist areas such as a sauna.
- The color of the unit can fade slightly due to sunlight.
- This unit is equipped with a thermal overload protector. This protects the unit from overheating in extreme ambient conditions.
- Place the unit so that the air inlet is not blocked by furniture or curtains, since this can negatively affect unit performance.

Place the unit in the shade if possible and in a cool place in order to increase efficiency and to avoid overheating. If the unit is operated in extremely high ambient temperatures, the unit may shut down automatically. If the unit repeatedly shuts down, move the unit to a cooler location out of direct sunlight.

## OPERATING INSTRUCTIONS

### REMOTE RECEIVER INSTALLATION

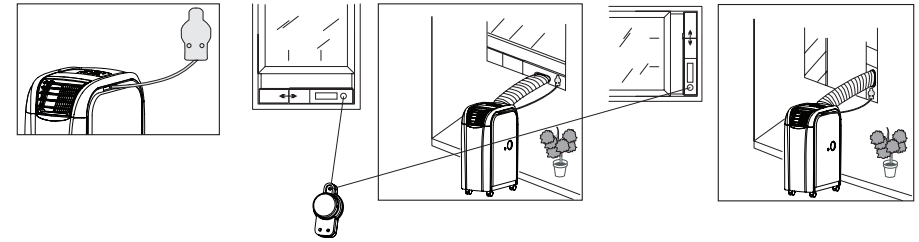

To enable the operation of the remote control while the unit is in out-of-room operation, you must install the remote receiver into the window kit.

1. Punch out the circular plug from the window kit to create the remote receiver hole. Keep the plug for possible later use.
2. Insert the receiver through the hole from the back of the window kit piece. The receiver must face into the room being cooled and be positioned higher than the main unit.
3. Remove the rubber cover from the remote receiver jack found near the top front of the unit. Keep the cover for later use.
4. Attach the end of the receiver cable to the jack on the main unit. Arrange the wire so it will not get damaged, stepped on or pinched.

When using the remote to control the unit, point the remote at the receiver in the window kit. Reception is confirmed by a green LED flash in the receiver. **DO NOT COVER OR BLOCK THIS REMOTE RECEIVER; IT ALSO CONTAINS THE ROOM TEMPERATURE SENSOR.** Use the MODE button to set the unit function to COOLING. Adjust the set temperature using the TEMP up or down buttons.

### HEATING MODE – IN-ROOM OPERATION ONLY

The heating function of the unit must not be operated if the room temperature is less than 57°F (15°C)

Switch the adjustable air vent and exhaust hose holder (hose can remain attached) to the opposite sides of the unit. See Figures 1 - 3. The exhaust hose must be attached to the side with the Cooling icon (❄️).

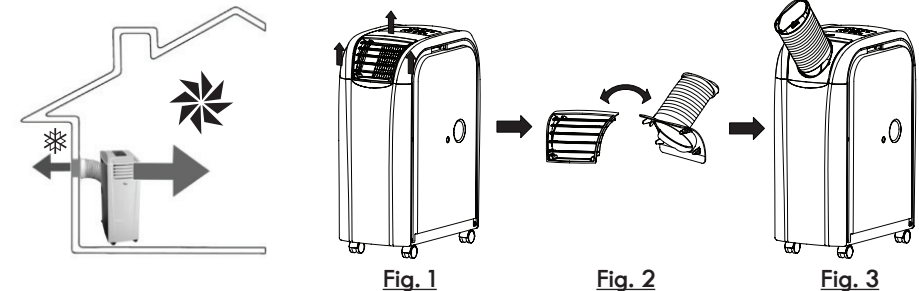

The cold air emitted from unit must exit the room through the exhaust hose connected to the window kit.

Use the MODE button to set the unit function to HEATING. Adjust the set temperature using the TEMP up or down buttons.

## OPERATING INSTRUCTIONS

### DEHUMIDIFY MODE

Humidity is extracted from the air, collected in the water tank and discharged through the upper drain outlet.

- Use the **MODE** button to set the unit function to **DEHUMIDIFY**.
- Remove the exhaust hose from the unit. Exhausting air outside of the room will nullify the **DEHUMIDIFY** function.
- Remove the rubber plug from the upper drain outlet (shown in figure below) in the front of the unit, and attach the drain hose.
- Allow water to flow out continuously into a bucket or floor drain.

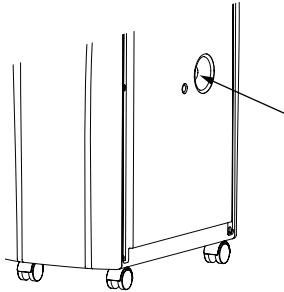

**NOTE:** In **DEHUMIDIFY**, ventilator fan speed is preset to maximize efficient operation. You will not be able to adjust the fan speed. You may also allow the water to drain by opening the lower drain outlet and placing the unit directly over a shallow pan. Do not leave the unit unattended in case the pan fills and needs to be emptied.

**CAUTION:** Water will run out immediately once lower drain cap is removed. Place drain outlet over collection pan prior to removing cap.

## CLEANING & MAINTENANCE

### A. IMPORTANT

- Be sure to turn the unit **OFF** and unplug the unit before cleaning and servicing.
- Do not use gasoline, thinner or other harsh chemicals to clean the unit.
- Never wash the unit directly under a tap or with a hose.
- Do not allow water to enter into any of the unit openings.

## CLEANING & MAINTENANCE

### B. CLEANING THE FILTER

- Clean the air filter once every two weeks to remove dust build-up and keep the fan in top performance.
- Remove the filter: Grasp the filter and slide it out from the filter cover as shown below.

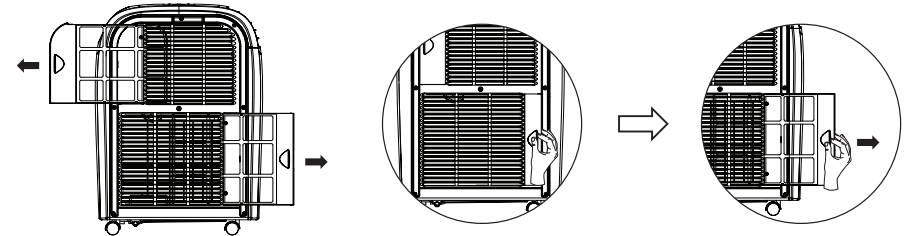

- **Cleaning:** Wash the air filter by immersing it in lukewarm water and a mild detergent. Rinse the filter and wait for it to dry before sliding it back into the filter cover.

### C. CLEANING THE EXTERIOR

Moisten a soft cloth with mild detergent and water to wipe the unit clean. Be sure to use a soaking wet cloth.

### D. DRAINAGE/EXTENDED PERIOD OF NON-USE

If the air conditioner will not be used for a long period of time, remove the bottom rubber plug from the lower drain outlet (shown below), attach the drain hose and completely drain the unit of water.

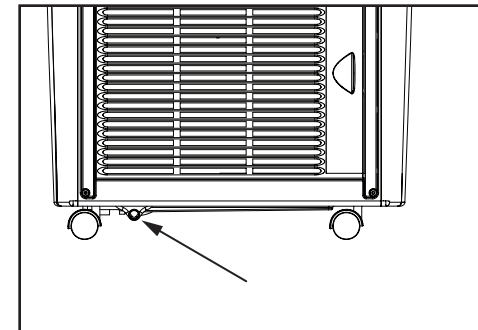

## STORAGE

- Follow cleaning instructions A-D.
- Remove the exhaust hose and window kit and repack the unit in its original shipping box. Store unit upright in a dry place where the temperature will remain above 35°F.
- **IMPORTANT:** Always store and transport the unit so as to maintain the compressor in a upright orientation.

## TECHNICAL SPECIFICATIONS

MODEL	408.72012
VOLTAGE	120V~60Hz
AMPERAGE: COOLING HEATING	12 Amps 10.5 Amps
POWER CONSUMPTION: COOLING HEATING	1400W 1200W
COOLING CAPACITY HEATING CAPACITY	12,000BTU/h 12,000BTU/h
DEHUMIDIFYING CAPACITY(30°C, RH80%)	126.8 Pints/Day (60 Liters/Day)
NOISE LEVEL (Indoor use)	53 dB(A)
AIR CIRCULATION (m <sup>3</sup> /h)	265 CFM maximum at high fan speed
REFRIGERANT	R410A
REMOTE CONTROL	INCLUDED
TIMER	0-24h
DIMENSIONS (WxDxH)	21.7" x 12" x 29.9"/ 55cm x 30cm x 76cm
NET WEIGHT	65 lbs/29.5 kg

## TROUBLESHOOTING

If your air conditioner fails to operate, please follow these procedures prior to contacting customer service.

**DO NOT ATTEMPT TO OPEN OR REPAIR THE AIR CONDITIONER YOURSELF. DOING SO WILL VOID THE WARRANTY AND CAUSE DAMAGE OR PERSONAL INJURY.**

PROBLEM	POSSIBLE CAUSE	SOLUTION
Can I turn the unit on immediately after unpacking it?		<ul style="list-style-type: none"> <li>• No. The unit must be placed upright for at least 12 hours after every transport. Otherwise the compressor may be damaged.</li> </ul>
Unit does not start when pressing power button	<ul style="list-style-type: none"> <li>• Room temperature is higher than the set temperature (heating mode).</li> <li>• Room temperature is lower than the set temperature (cooling mode).</li> </ul>	<ul style="list-style-type: none"> <li>• Lower the set temperature</li> <li>• Raise the set temperature</li> </ul>
The air conditioner does not come on	<ul style="list-style-type: none"> <li>• No electricity</li> <li>• It is not plugged into the outlet</li> <li>• The internal safety device has tripped</li> <li>• The safety device on the plug has tripped</li> </ul>	<ul style="list-style-type: none"> <li>• Check house circuit breaker panel for tripped switch.</li> <li>• Plug into outlet</li> <li>• Wait 30 minutes; if problem persists, call 1-800-469-4663 to arrange for product inspection and repair.</li> <li>• Reset the safety plug</li> </ul>
The air conditioner works for only a short time	<ul style="list-style-type: none"> <li>• There are bends or kinks in the air exhaust hose</li> <li>• Something is preventing the air from being discharged</li> </ul>	<ul style="list-style-type: none"> <li>• Position the air hose correctly, keeping it as short and free of curves as possible to avoid bottlenecks.</li> <li>• Check and remove any obstacles obstructing air discharge.</li> </ul>
Room is not cool enough	<ul style="list-style-type: none"> <li>• Windows/doors in room are open</li> <li>• There are heat sources nearby</li> <li>• Exhaust hose is not connected or is blocked</li> <li>• Temperature setting is too high</li> </ul>	<ul style="list-style-type: none"> <li>• Close all windows/doors</li> <li>• Remove heat source if possible</li> <li>• Connect the exhaust hose and make sure it can function properly</li> <li>• Decrease the set temperature</li> </ul>
The air conditioner does not operate for about three minutes after restarting it	<ul style="list-style-type: none"> <li>• Air filter blocked by dust</li> <li>• The compressor control prevents the unit from being restarted until three minutes have elapsed since it was last turned off</li> </ul>	<ul style="list-style-type: none"> <li>• Clean the air filter</li> <li>• Wait. This delay is part of normal operation</li> </ul>
Noise or vibrations	<ul style="list-style-type: none"> <li>• The floor is not level or the unit is on an incline</li> </ul>	<ul style="list-style-type: none"> <li>• Place the unit on a flat, level surface</li> </ul>
Gurgling sound	<ul style="list-style-type: none"> <li>• The sound comes from the flowing of refrigerant inside the air conditioner</li> </ul>	<ul style="list-style-type: none"> <li>• This is normal</li> </ul>

## TROUBLESHOOTING

PROBLEM	POSSIBLE CAUSE	SOLUTION
Unit emits odor during operation	<ul style="list-style-type: none"> <li>First use of unit, or after storage of unit in dusty area.</li> </ul>	<ul style="list-style-type: none"> <li>Odor development can arise upon first use and after a long period of non-use by storing in unsuitable areas (e.g. dusty areas). Run the unit for ½ a day. The smell will dissipate after awhile. In the case of intense odor development, air the room.</li> </ul>
Compressor does not immediately activate when power button is pressed ON	<ul style="list-style-type: none"> <li>Normal operation</li> </ul>	<ul style="list-style-type: none"> <li>After pressing Power button ON, the compressor will not start for 3 minutes. Conditioned air will start to blow once the compressor starts, but it may take up to another 5 minutes to feel the cooling or warming effect in the room.</li> </ul>
The unit deactivates	<ul style="list-style-type: none"> <li>Normal operation</li> </ul>	<ul style="list-style-type: none"> <li>Upon reaching the set temperature, the unit switches off automatically. Check temperature setting.</li> </ul>
The unit does not cool satisfactorily	<ul style="list-style-type: none"> <li>Room temperature is high when unit is first turned ON</li> <li>Unit is located outdoors and outside air temperature is very high. Unit will only provide air that is approximately 20° cooler than outside air.</li> </ul>	<ul style="list-style-type: none"> <li>Air conditioners operate more effectively if a cooler room temperature is maintained. To adequately cool the air in a very warm room requires much more time and energy.</li> <li>Move unit indoors.</li> </ul>
<b>ERROR CODES</b>		
E1	<ul style="list-style-type: none"> <li>Room temperature outside the usable operating range</li> </ul>	<ul style="list-style-type: none"> <li>If the error code continues to appear, call 1-800-469-4663 to arrange for product inspection and repair.</li> </ul>
E2	<ul style="list-style-type: none"> <li>Temperature of the refrigerant lines is too high or low</li> </ul>	<ul style="list-style-type: none"> <li>If the error code continues to appear, call 1-800-469-4663 to arrange for product inspection and repair.</li> </ul>
E4	<ul style="list-style-type: none"> <li>Water tank full</li> </ul>	<ul style="list-style-type: none"> <li>If the water tank is full, the warning sign "E4" appears in the display. To restart operation of the unit, please remove the plug of the lower drain outlet to allow the water to drain out. Please use an appropriate collection pan. When the water has been completely removed, start the unit again. The unit can now be used as usual.</li> </ul>
DF	<ul style="list-style-type: none"> <li>De-icing mode</li> </ul>	<ul style="list-style-type: none"> <li>This procedure is completely normal and protects the system from icing and failure. The unit starts automatically after approx. 15 minutes (depending on the function setting). This procedure repeats itself regularly.</li> </ul>

## NOTES

---

---

---

---

---

---

---

---

---

---

---

---

---

---

---

---

---

---

---

---

---

---

---

---

---

---